

# SERRATURA TAGLIAFUOCO



---

9100



Serie:

## E9100 (Resistente al Fuoco)



### Serratura tagliafuoco (Reversible)

- Serratura zincata con frontale in acciaio
- Cassa in acciaio zincato
- Per l'intera serie - Scrocco Zincato e regolabile
- 9 mm quadro maniglia
- Cilindro escluso



Serie:

## E9110



### Scrocco e catenaccio

- **Operazione:**  
-Entrata

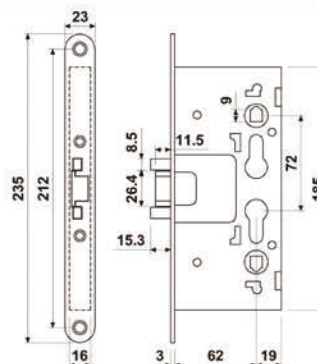

riferimento	interasse	frontale	entrata	giri chiave
E9110	72	23	65	1



Serie:

## E9113



### Scrocco

- **Operazione:**  
-Entrata
- Scrocco regolabile a mezzo vite

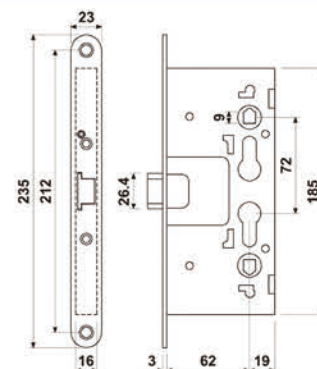

riferimento	interasse	frontale	entrata	giri chiave
E9113	72	23	65	1



Serie:  
**E9115**



**Entrata chiusura with antipanico funzione**

- **Operazione:**
  - Interno: Funzione antipanico agendo sulla maniglia
  - Esterno: Lo scrocco sia il catenaccio funzionano solo con chiave
- Quadro maniglia diviso in 2 pezzi

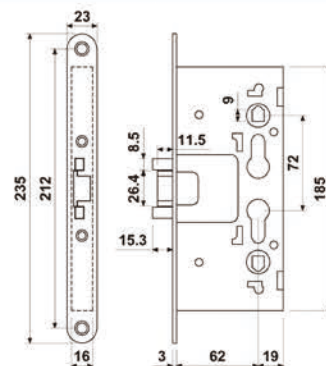

referimento	interasse	frontale	entrata	giri chiave
E9115	72	23	65	1



Serie:  
**E9119**



**Chiusura solo scrocco**

- **Operazione:**
  - Interno: Scrocco bloccato dalla chiave ed azionato dalla maniglia.
  - Esterno lo scrocco può essere bloccato solo dalla chiave e la maniglia funziona solo se lo scrocco è libero
- 2pcs quadro maniglia
- Scrocco regolabile a mezzo vite

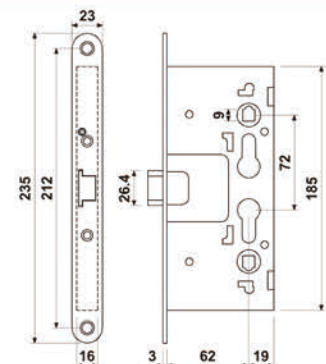





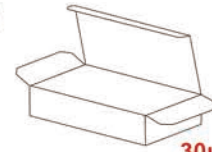

referimento	interasse	frontale	entrata	giri chiave
E9119	72	23	65	1

## Serie TE - N05

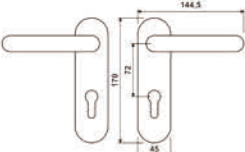
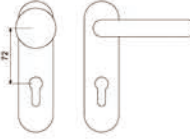
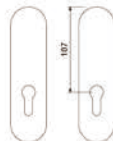
- Maniglia in Nylon resistente al fuoco
- Placca interna in acciaio
- Quadro maniglia 9 mm

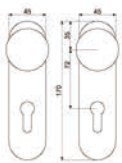
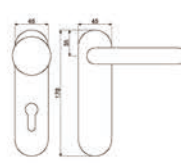
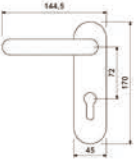
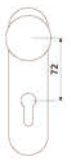

30uds

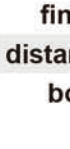
<b>modello</b> 	<b>riferiment</b> TE - N05 <b>finitura</b> negro <b>distancia e.e</b> 72 <b>bordo</b> redondo	<b>modello</b> 	<b>riferiment</b> TE - N06 <b>finitura</b> negro <b>distancia e.e</b> 72 <b>bordo</b> redondo
<b>modello</b> 	<b>riferiment</b> TE - N07 <b>finitura</b> negro <b>distancia e.e</b> 72 <b>bordo</b> redondo	<b>modello</b> 	<b>riferiment</b> TE - N08 <b>finitura</b> negro <b>distancia e.e</b> 72 <b>bordo</b> redondo
<b>modello</b> 	<b>riferiment</b> TE - N09 <b>finitura</b> negro <b>distancia e.e</b> 72 <b>bordo</b> redondo	<b>modello</b> 	<b>riferiment</b> TE - N10 <b>finitura</b> negro <b>distancia e.e</b> 72 <b>bordo</b> redondo
<b>modello</b> 	<b>riferiment</b> TE-N19 <b>finitura</b> negro <b>distancia e.e</b> 72 <b>bordo</b> redondo	<b>modello</b> 	<b>riferiment</b> TE-N20 <b>finitura</b> negro <b>distancia e.e</b> 72 <b>bordo</b> redondo
<b>modello</b> 	<b>riferiment</b> TE-N05H <b>finitura</b> negro <b>distancia e.e</b> 72 <b>bordo</b> redondo	<b>modello</b> 	<b>riferiment</b> TE-N06H <b>finitura</b> negro <b>distancia e.e</b> 72 <b>bordo</b> redondo
<b>modello</b> 	<b>riferiment</b> TE-N07H <b>finitura</b> negro <b>distancia e.e</b> 72 <b>bordo</b> redondo	<b>modello</b> 	<b>riferiment</b> TE-N08H <b>finitura</b> negro <b>distancia e.e</b> 72 <b>bordo</b> redondo
<b>modello</b> 	<b>riferiment</b> TE-N09H <b>finitura</b> negro <b>distancia e.e</b> 72 <b>bordo</b> redondo	<b>modello</b> 	<b>riferiment</b> TE-N010H <b>finitura</b> negro <b>distancia e.e</b> 72 <b>bordo</b> redondo



## Serie TE - N11



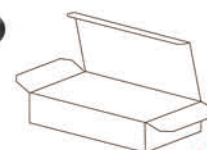

- Maniglia in Nylon resistente al fuoco
- Placca interna in acciaio
- Quadro maniglia 9 mm

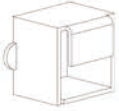

30uds

<b>modello</b> 	<b>riferiment</b> <b>finitura</b> <b>distancia e.e</b> <b>bordo</b>	TE - N11 negro 72 cuadrado	<b>modello</b> 	<b>riferiment</b> <b>finitura</b> <b>distancia e.e</b> <b>bordo</b>	TE - N12 negro 72 cuadrado
<b>modello</b> 	<b>riferiment</b> <b>finitura</b> <b>distancia e.e</b> <b>bordo</b>	TE - N13 negro 72 cuadrado	<b>modello</b> 	<b>riferiment</b> <b>finitura</b> <b>distancia e.e</b> <b>bordo</b>	TE - N14 negro 72 cuadrado
<b>modello</b> 	<b>riferiment</b> <b>finitura</b> <b>distancia e.e</b> <b>bordo</b>	TE - N15 negro 72 cuadrado	<b>modello</b> 	<b>riferiment</b> <b>finitura</b> <b>distancia e.e</b> <b>bordo</b>	TE - N16 negro 72 cuadrado
<b>modello</b> 	<b>riferiment</b> <b>finitura</b> <b>distancia e.e</b> <b>bordo</b>	TE - N17 negro 72 cuadrado	<b>modello</b> 	<b>riferiment</b> <b>finitura</b> <b>distancia e.e</b> <b>bordo</b>	TE - N18 negro 72 cuadrado
<b>modello</b> 	<b>riferiment</b> <b>finitura</b> <b>distancia e.e</b> <b>bordo</b>	TE - N11H negro 72 cuadrado	<b>modello</b> 	<b>riferiment</b> <b>finitura</b> <b>distancia e.e</b> <b>bordo</b>	TE - N12H negro 72 cuadrado
<b>modello</b> 	<b>riferiment</b> <b>finitura</b> <b>distancia e.e</b> <b>bordo</b>	TE - N13H negro 72 cuadrado	<b>modello</b> 	<b>riferiment</b> <b>finitura</b> <b>distancia e.e</b> <b>bordo</b>	TE - N14H negro 72 cuadrado
<b>modello</b> 	<b>riferiment</b> <b>finitura</b> <b>distancia e.e</b> <b>bordo</b>	TE - N15H negro 72 cuadrado	<b>modello</b> 	<b>riferiment</b> <b>finitura</b> <b>distancia e.e</b> <b>bordo</b>	TE - N16H negro 72 cuadrado

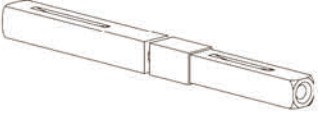
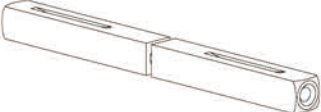
## Accessorios

perni ed adattatori	riferimento	descrizione	misura (mm)
	NA-89-7	Adattatori da 9 a 8	7,4
	NA-89-40	Adattatore quadro maniglia da 9 ad 8	40
	NS-98-110	Doppio perno snodato 8/9 + 9/9	8 x 9 x 110
	NS-9X-110	Doppio perno snodato 9/9	9 x 9 x 110
	NS-9T-125	Quadro perno	9 x 9 x 125