

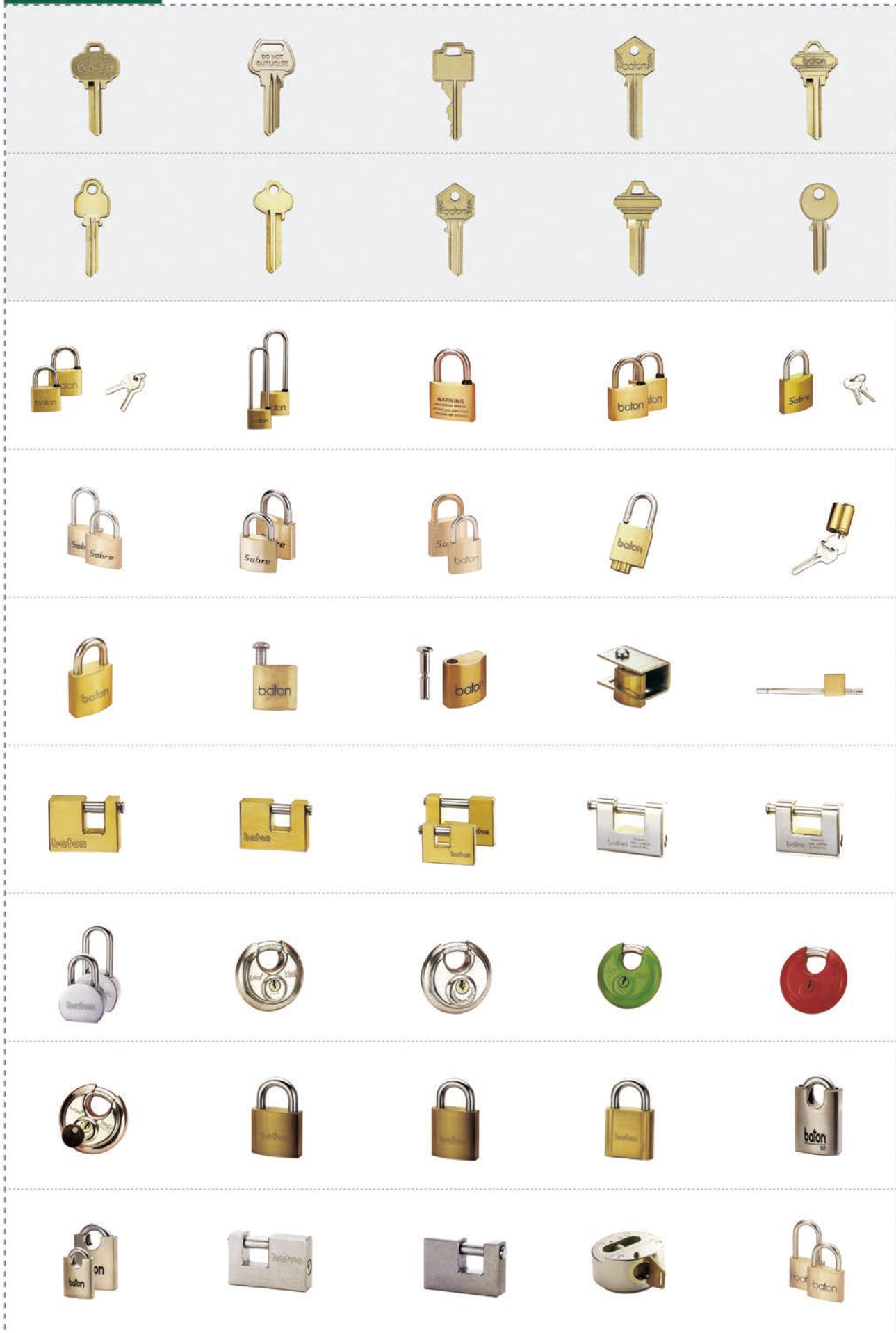













































**LUCCHETTI**



**INDEX**



**INDEX**

**INDEX**



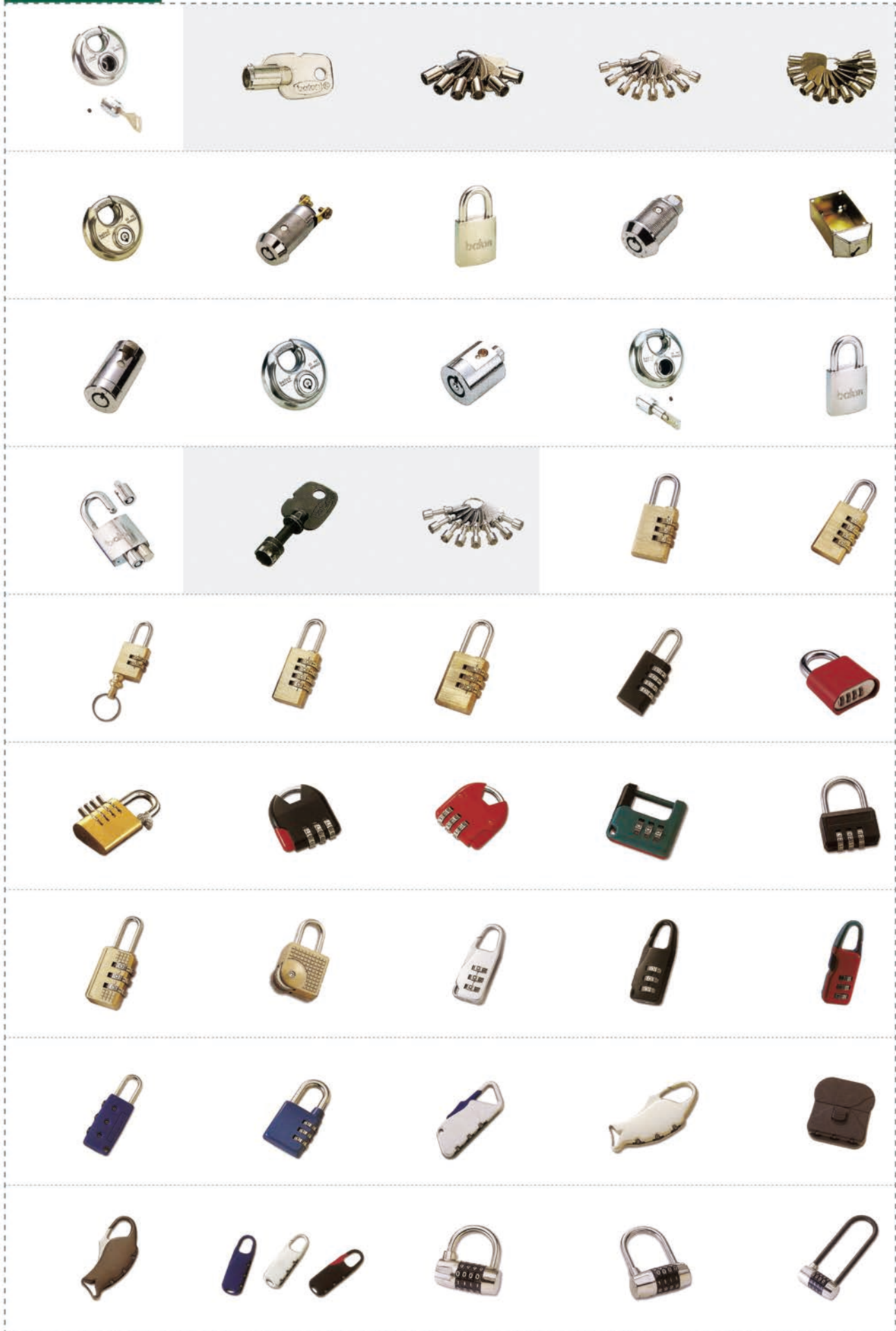

Serie:

## 761S Lucchetto ad arco di sicurezza



### Lucchetto in solido ottone

- Arco in acciaio temperato
- Anello in gomma per protezione del meccanismo interno - dimensione 40, 50 e 60 mm
- Arco standard e grande
- Doppio sistema di chiusura
- 2 chiavi
- Possibilità di KA e KD
- Prezzo llave en bruto (761S- 20,25,30 KB ) 0,24 €
- Prezzo llave en bruto (761S- 40,50,60 KB) 0,28 €

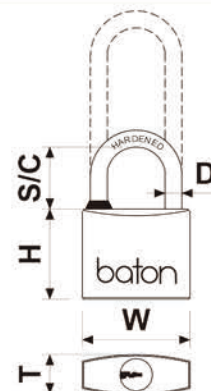

riferimento	W	H	T	D	S/C
BB763S15DBY1USBB	15 mm	18.1 mm	9.4 mm	3.0 mm	11.4mm
BB762S20DBY1USBB	20 mm	19.0 mm	11 mm	3.5 mm	12 mm
BB762S25DBY1USBB	25 mm	21.0 mm	12 mm	4.0 mm	14 mm
BB761S30DBY3USBB	30 mm	28.2 mm	13 mm	5.0 mm	17 mm
BB761S40DBY5USBB	40 mm	33.5 mm	15 mm	6.0 mm	23 mm
BB761S50DBY7USBB	50 mm	41.0 mm	17 mm	8.0 mm	30 mm
BB761S60DBY7USBB	60 mm	43.0 mm	19 mm	9.5 mm	35 mm
BB762L20DBY1USBB	20 mm	19.0 mm	11 mm	3.5 mm	23 mm
BB762L25DBY1USBB	25 mm	21.0 mm	12 mm	4.0 mm	26 mm
BB761L30DBY3USBB	30 mm	28.2 mm	13 mm	5.0 mm	32 mm
BB761L40DBY5USBB	40 mm	33.5 mm	15 mm	6.0 mm	41 mm
BB761L50DBY7USBB	50 mm	41.0 mm	17 mm	8.0 mm	49 mm
BB761L60DBY7USBB	60 mm	43.0 mm	19 mm	9.5 mm	61 mm



Serie:

## 761T Lucchetto ad arco di sicurezza



### Lucchetto monoblocco in ottone

- Arco in acciaio inossidabile
- Anello in gomma per protezione del meccanismo interno - dimensione 40, 50 e 60 mm
- Arco standard e grande
- Doppio sistema di chiusura
- 2 chiavi
- Possibilità di KA e KD

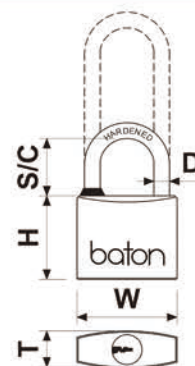

riferimento	W	H	T	D	S/C
BB761T30DBY3SCBB	30	28.2	13	5.0	17
BB761T40DBY5SCBB	40	33.5	15	6.0	23
BB761T50DBY7SCBB	50	41	17	8.0	30
BB761T60DBY7SCBB	60	43	19	9.5	35
BB761C30DBY3SCBB	30	28.2	13	5.0	32
BB761D40DBY5SCBB	40	33.5	15	6.0	41
BB761E50DBY7SCBB	50	41	17	8.0	49
BB761G60DBY7SCBB	60	43	19	9.5	61



Serie:

## 764S Luchetto economico in ottone



### Lucchetto in solido ottone

- Arco in acciaio nichelato
- Arco standard e grande
- Sistema di chiusura singolo
- 2 chiavi
- Possibilità di KA e KD
- Prezzo llave en bruto (764S-20,25,30 KB) 0,24 €
- Prezzo llave en bruto (764S-40,50,60 KB) 0,28 €

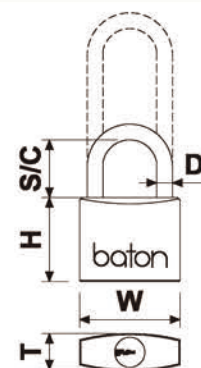

riferimento	W	H	T	D	S/C
FB764S20DBV1USBB	20 mm	18.8 mm	8.7 mm	3.2 mm	13.3 mm
FB764S25DBV2USBB	25 mm	22 mm	9.2 mm	4.0 mm	13.0 mm
FB764S30DBV3USBB	30 mm	24 mm	9.8 mm	4.5 mm	15.0 mm
FB764S35DBV3USBB	35 mm	27 mm	9.3 mm	5.0 mm	21.0 mm
FB764S40DBV3USBB	40 mm	30 mm	10.9 mm	6.0 mm	21.0 mm
FB764S45DBV4USBB	45 mm	33 mm	11.6 mm	6.3 mm	22.6 mm
FB764S50DBV4USBB	50 mm	36 mm	12.3 mm	7.0 mm	25.6 mm
FB764S60DBV4USBB	60 mm	40 mm	14.0 mm	8.0 mm	31.3 mm
FB764L40DBV3USBB	40 mm	30 mm	10.0 mm	6.0 mm	41.0 mm
FB764L50DBV4USBB	50 mm	36 mm	11.9 mm	7.0 mm	49.0 mm
FB764L60DBV4USBB	60 mm	40 mm	12.5 mm	7.5 mm	61.0 mm

# SERIE BZ761S



Serie:

## BZ761S Luchetto Alutitanium Protetto



### Corpo in Monoblocco in Titanio (Alluminio)

- Arco in acciaio temprato
- Disponibile nelle misure 30,40 e 50mm con arco Standard o Lungo
- Meccanismo con doppia chiusura
- Profilo chiave paracentrico contro manipolazione.
- Rotore del cilindro cromato.
- 3 chiavi incluse.
- Possibilità di chiavi uguali KA.

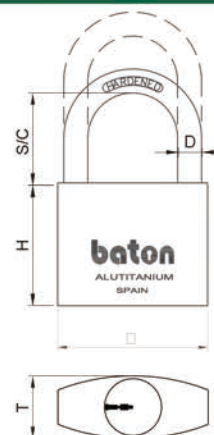

riferimento	W	H	T	D	S/C
BZ761S30DBY3USBB	30	28,2	13	5,0	17
BZ761S40DBY5USBB	40	33,5	15	6,0	23
BZ761S50DBY7USBB	50	41,0	17	8,0	30
BZ761L30DBY3USBB	30	28,2	13	5,0	32
BZ761L40DBY5USBB	40	33,5	15	6,0	41
BZ761L50DBY7USBB	50	41,0	17	8,0	49

\*\*\* Disponibilidad de expositor en esta serie de candados ALUTITANIUM \*\*\*



**Serie:**

## 760 Lucchetto in ottone con chiusura a perno

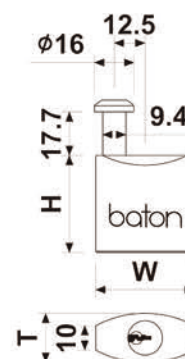

### Lucchetto in solido ottone

- Fungo di chiusura rotante in acciaio temprato
- Per chiudere buchi da 9 a 11 mm
- Chiusura semplice
- 2 chiavi



riferimento	W	H	T	D	S/C
BB760Y40DBC1USBB	40 mm	39.5 mm	20 mm	9,4 mm	16 mm

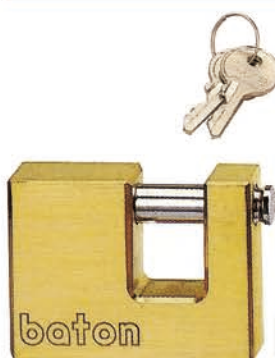

**Serie:**

## 770A Lucchetto di sicurezza

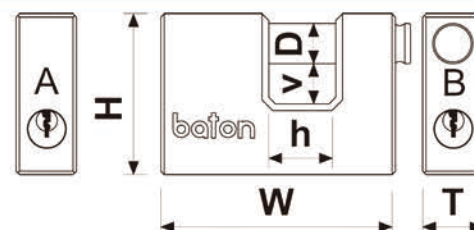

### Lucchetto in solido ottone

- Perno di chiusura in acciaio temprato
- Chiusura di sicurezza a mezzo sfera
- 2 chiavi
- Possibilità di KA e KD
- Prezzo llave en bruto 770F- KB 0,28 €



riferimento	W	H	T	D	S/C v-h
BA770R50DBY5USBB	50 mm	38 mm	15 mm	7 mm	16 mm / 12 mm
BA770R70DBY7USBB	70 mm	48 mm	18 mm	12 mm	20 mm / 12 mm
BA770R90DBY7USBB	90 mm	60 mm	18 mm	12 mm	36 mm / 20 mm



**Serie:**

## 770F Lucchetto incamiciato di sicurezza

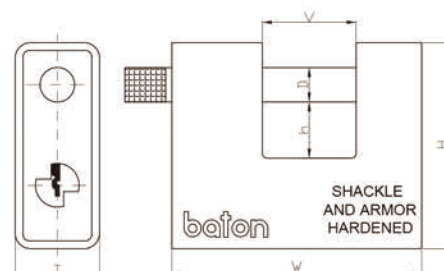

### Lucchetto in solido ottone incamiciato con acciaio temprato finitura cromata

- Perno di chiusura in acciaio temprato
- Chiusura di sicurezza a mezzo sfera
- 3 chiavi
- Prezzo llave en bruto 770F- KB 0,28 €



riferimento	W	H	T	D	S/C v-h
BH770R60DCY7SCBB	60 mm	56 mm	24 mm	10 mm	22 mm / 12 mm
BH770R80DCY7SCBB	80 mm	66 mm	27 mm	11 mm	30 mm / 14 mm
BH770R90DCY7SCBB	90 mm	72 mm	28 mm	12 mm	36 mm / 18 mm





Serie:

## 771 Lucchetto ad arco in acciaio temprato



### Corpo acciaio temprato finitura cromosatinata

- Arco in acciaio temperato
- Sistema con Doppia sfera di chiusura
- 3 chiavi

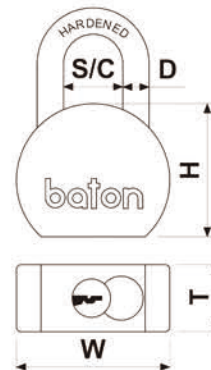

riferimento	W	H	T	D	S/C
BT771S64DBY7CPBB	64 mm	56 mm	28 mm	11 mm	29
BT771U64DBY7CPBB	64 mm	56 mm	28 mm	11 mm	55



Serie:

## 786 Lucchetto impermeabile



### Lucchetto in acciaio

- Corpo ed arco ricoperti di gomma
- Arco in acciaio temperato
- Sistema con Doppia sfera di chiusura
- Protezione a tappo per il cilindro
- 2 chiavi

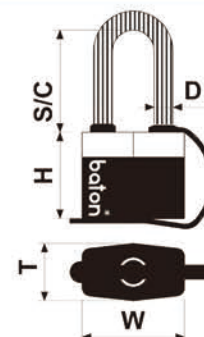

riferimento	W	H	T	D	S/C
WP786M50DBM4PCBS	55 mm	40 mm	31.6 mm	10 mm	43.7 mm



Serie:

## 5141 Lucchetto in ottone con chiave piatta



### Lucchetto in solido ottone

- Arco in acciaio temperato
- Sistema con Doppia sfera di chiusura
- Cilindro in ottone con 5 o 6 perni
- 2 chiavi piatte fornite

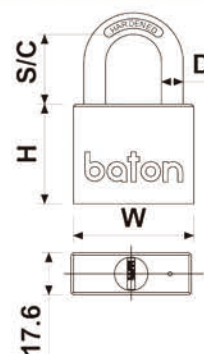

riferimento	W	H	T	D	S/C
5141S40DCN5BUSBB	40 mm	35 mm	17,6 mm	6 mm	24 mm
5141S50DCN5BUSBB	50 mm	35 mm	17,6 mm	9 mm	29 mm
5141S60DCN5BUSBB	60 mm	35 mm	17,6 mm	11 mm	34 mm



Serie:

## 5200 Lucchetto corazzato con chiave piatta



**Lucchetto in solido ottone incamiciato con acciaio temprato**

- Perno di chiusura in acciaio temprato
- Chiusura di sicurezza a mezzo sfera
- Cilindro in ottone con 6 perni
- 3 chiavi piatte fornite

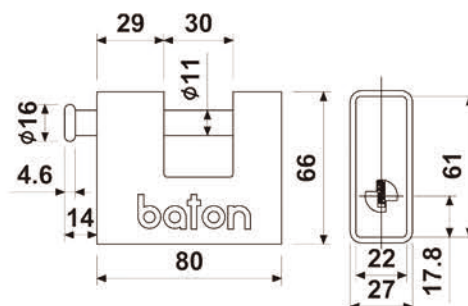

riferimento	W	H	T	D	S/C v-h
5200A80DBN5HSCBB	80 mm	66 mm	27 mm	12 mm	30 mm / 18 mm



Serie:

## 5772 Lucchetto a disco



**Lucchetto in acciaio inox, sia corpo che meccanismo - saldature al laser**

- Arco in acciaio temprato
- Cilindro in ottone con 6 perni
- 2 chiavi piatte fornite

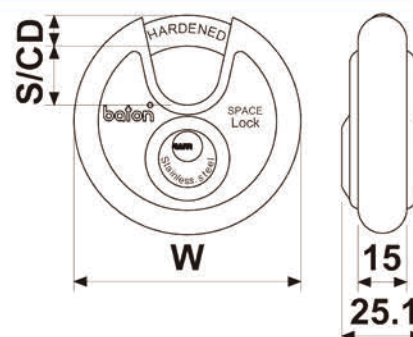

riferimento	W	H	T	D	S/C
BT577270DBP5USOB	70 mm	67,7 mm	15 mm	9,5 mm	17 mm
BT577280DBP5USOB	80 mm	67,7 mm	15 mm	12 mm	20 mm
BT577290DBP5USOB	90 mm	67,7 mm	15 mm	12 mm	23 mm



Serie:

## 6320 Cilindro in ottone (Chiusura a dischi)



**Lucchetto in ottone cromosatinato**

- Arco in acciaio temprato
- Sistema con Doppia sfera di chiusura
- Meccanismo di chiusura rotante a dischi
- Cilindro ricicfrabile
- Estrazione chiave solo in posizione di chiusura
- 3 chiavi fornite

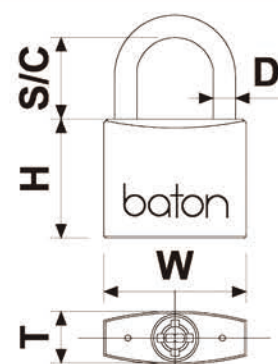

riferimento	W	H	T	D	S/C
6320S50DCD3BSCBB	50 mm	38 mm	20 mm	10 mm	29 mm
6320S60DCD3BSCBB	60 mm	43 mm	20 mm	11 mm	34 mm
6320S70DCD3BSCBB	70 mm	45 mm	20 mm	12 mm	40 mm



Serie:

## 6150 Lucchetto in ottone con arco protetto (Chiusura a dischi)



### Lucchetto in ottone con finitura nichelsatinata

- Arco in acciaio temperato
- Sistema con Doppia sfera di chiusura
- Meccanismo di chiusura rotante a dischi
- Cilindro ricifrabile
- Estrazione chiave solo in posizione di chiusura
- 3 chiavi fornite

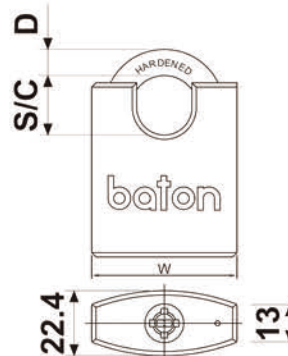

riferimento	W	H	T	D	S5.15/C
6150S40DCD3B14BB	40 mm	56 mm	22,4 mm	7,3 mm	16 mm
6150S50DCD3B14BB	50 mm	64 mm	22,4 mm	9.0 mm	21 mm
6150S60DCD3B14BB	60 mm	75 mm	22,4 mm	11.0 mm	23 mm



Serie:

## 790-4 Lucchetto a combinazione



### Lucchetto a combinazione in ottone

- Arco in acciaio temperato
- Apertura senza chiave ma con serie di 4 numeri
- Combinazione ricifrabile

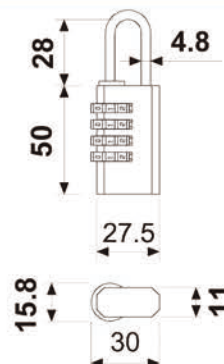

riferimento	W	H	T	D	S/C v-h
CB790S30D4BBUSBS	27.5 mm	50 mm	11 mm	4.8 mm	28 mm



Serie:

## 790-3 Lucchetto a combinazione



### Lucchetto a combinazione in ottone

- Arco in acciaio temperato
- Apertura senza chiave ma con serie di 3 numeri
- Combinazione ricifrabile

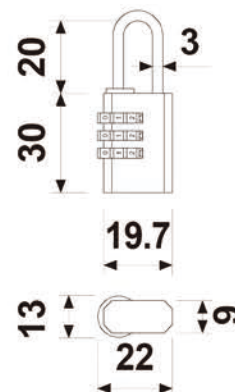

riferimento	W	H	T	D	S/C v-h
CB790S20D3BBUSBS	19.7 mm	30 mm	9 mm	3.0 mm	20 mm